

## VARIMETER

Current relay

MK 9063N, MH 9063



### Your Advantages

- Preventive maintenance
- For better productivity
- Quicker fault locating
- Precise and reliable
- Min-, Max. value or window monitoring
- Measuring ranges up to AC/DC 10 A
- Simple configuration and fault diagnostic
- Auxiliary voltage ranges DC 24 V or AC/DC 110 ... 400 V

### Features

- According to IEC/EN 60 255-1
- AC/DC current measuring (single-phase)
- Start up delay, on delay
- Manual reset
- LCD for indication of the measuring values
- Relay output
  - MK 9063N: 1 changeover contact
  - MH 9063: 2 x 1 changeover contacts
- Relay function selectable (energized/de-energized on trip)
- As option with plugable terminal blocks for easy exchange of devices
  - with screw terminals
  - or with cage clamp terminals
- Width MK 9063N: 22.5 mm
- Width MH 9063: 45.0 mm

### Product Description

The current relays MK 9063N and MH 9063 of the varimeter family provide a solution for an optimised monitoring of the function or the load current of an electrical device. Single-phase AC and also DC can be measured, undercurrent, overcurrent and current window are monitored and the measured value is displayed on the front.

### Function Diagram

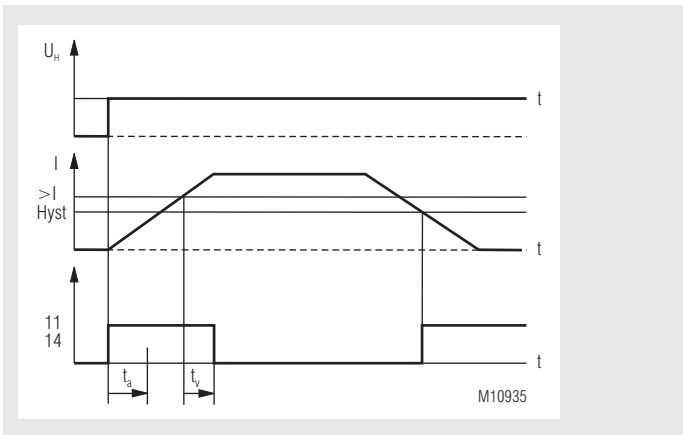

Example: overcurrent monitoring with de-energized on trip

### More Information

- **MH 9063**  
The MH 9063 has 2 relay outputs.  
The current monitoring can be assigned to relay 1 and /or relay 2

### Approvals and Markings



### Applications

- Current monitoring AC/DC single-phase
- Current dependent switching at under- or overcurrent

### Circuit Diagrams

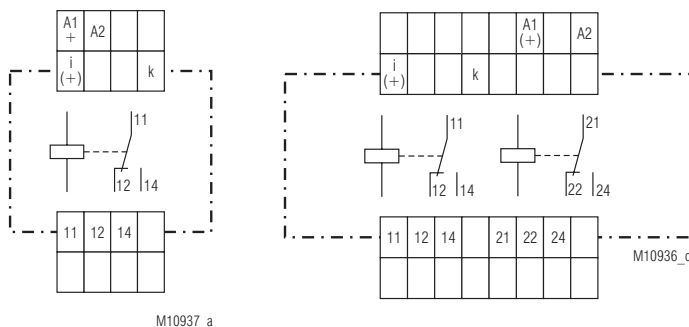

MK 9063N.11

MH 9063.12

### Connection Terminals

Terminal designation	Signal designation
A1(+), A2	Auxiliary voltage AC or DC
i(+)	Current measuring circuit (+) Input DC, AC
k	Current measuring circuit Output DC, AC
11,12,14	Indicator relay (C/O contact)
21, 22, 24	Indicator relay (C/O contact)

## Function

The Device is programmable for AC- or DC- measuring.  
On AC-measurement the rectified mean value is measured.  
On sinusoidal input signals the RMS value is displayed.

After connecting the auxiliary supply to terminals A1-A2 the startup delay disables the monitoring function so that changes on the input have no influence on the relay output of the VARIMETER.

The device is in display (RUN) mode and continuously measures the actual values. Pressing  for more than 3 sec starts the input mode.

If the setting value is exceeded the relay switches and the display indicates this state. The display is inverted, flashes and shows the error.

The fault memory is selectable

With button  the fault memory can be deleted.

On the unit MH 9063 it is possible to assign different functions to the different relays so one can be used as pre-warning and the other as alarm output. Relay output 1 switches when actual value exceeds the pre-warning setting. If a second setting assigned to relay output 2 the unit gives an Alarm signal.

## Remarks

The unit needs a connected auxiliary supply.  
It is designed for single phase AC/DC measurement.

## Setting

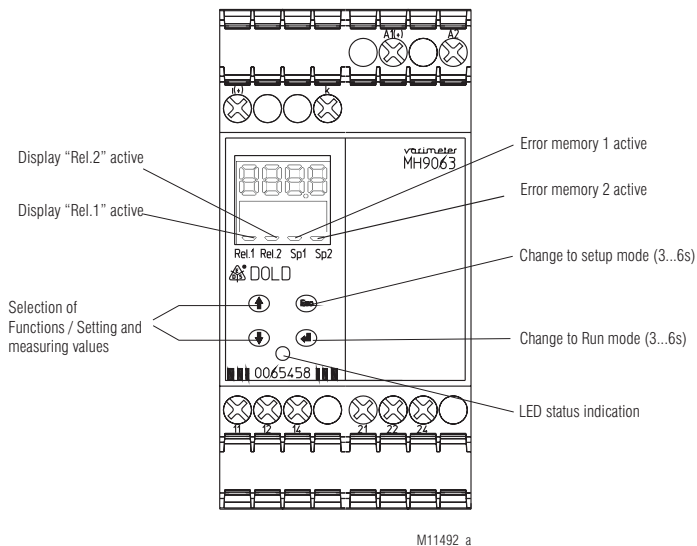

## Indicators

The LED indicates the state.

green:	on, when auxiliary voltage present
orange (flashes):	No measurement; unit in input mode
red (short On, short Off):	Failure overvoltage

**If the measured value is higher then the upper end of scale value, the display shows the fault message "OL"**

## Cursor LCD Display

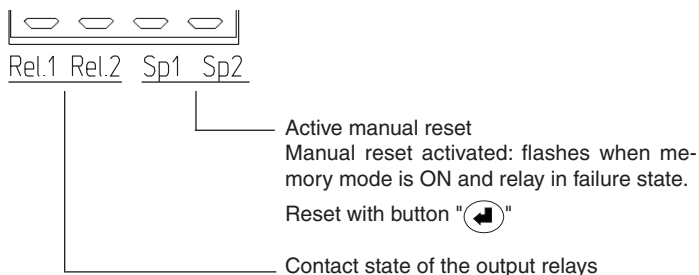

## Operating

### Display (Run) - Mode

### Input-Mode

#### ⬆️ UP / ⬇️ DOWN

After power up the relay is in display (Run) mode.

⬆️ ⬇️ buttons have no function

The measurement is interrupted, the relays are in failure state and the indicator LED has orange color

⬆️ ⬇️ Selection of parameters and setting of thresholds

#### ⬅️ ENTER

Manual reset, when manual reset is selected for output relay  
Reset works only when fault is removed

- Shifts cursor to the right  
- Saves the value no-voltage safe  
- Pressing for more than 3 sec: Change to display (Run) mode

#### Ⓜ️ Esc

- Pressing for more than 3 sec: Change to input mode

- Shifts cursor to the left  
- Leave setting without saving

## LCD-Display



Rel.1 Rel.2 Sp1 Sp2



Rel.1 Rel.2 Sp1 Sp2



Rel.1 Rel.2 Sp1 Sp2



Rel.1 Rel.2 Sp1 Sp2

## Setting Parameter

< | Fault, when value drops under set point  
> | Fault, when value exceeds set point  
OFF Measurement disabled

If the adjusted threshold of at least one measuring function is exceeded, the corresponding relay output switches after the selected time delay  $t_v$  and the fault is indicated on the display.

Manual reset can be activated or de-activated and is operated with ⬅️ on the unit.

### Adjustable Parameter

Limit values for Rel.1 and Rel.2 Selectable with buttons ⬆️ ⬇️.		Factory setting
< :	Response value undercurrent (Undercurrent relay)	OFF
> :	Response value overcurrent , (Overcurrent relay)	*
Hyst:	Response value hysteresis	5 %
$t_v$ :	On delay for relays ( 0 ... 10 sec )	0 s
A / R:	Setting open- / closed circuit operation	R
Sp:	Error storage ( ON / OFF )	OFF

Response values can be deactivated. (OFF)

\*) dependent to device-variant (measuring range)

### Further Setting Parameter

Selectable with buttons ⬆️ ⬇️.		Factory setting
$t_s$ :	Start up delay, when auxiliary voltage connected ( 0.2 ... 10 s )	0,2 s
AC/DC	Measuring current AC or DC	AC

### Restore Factory Settings

(Restore factory settings)

Before auxiliary voltage connected press button Ⓜ️ .  
During start press and hold.

### Indicator output

The switching mode energized or de-energized on trip can be set in input mode. The MH 9063 has 2 relay outputs. Monitoring function can be assigned to Relay 1 and/or to Relay 2.

## Operating

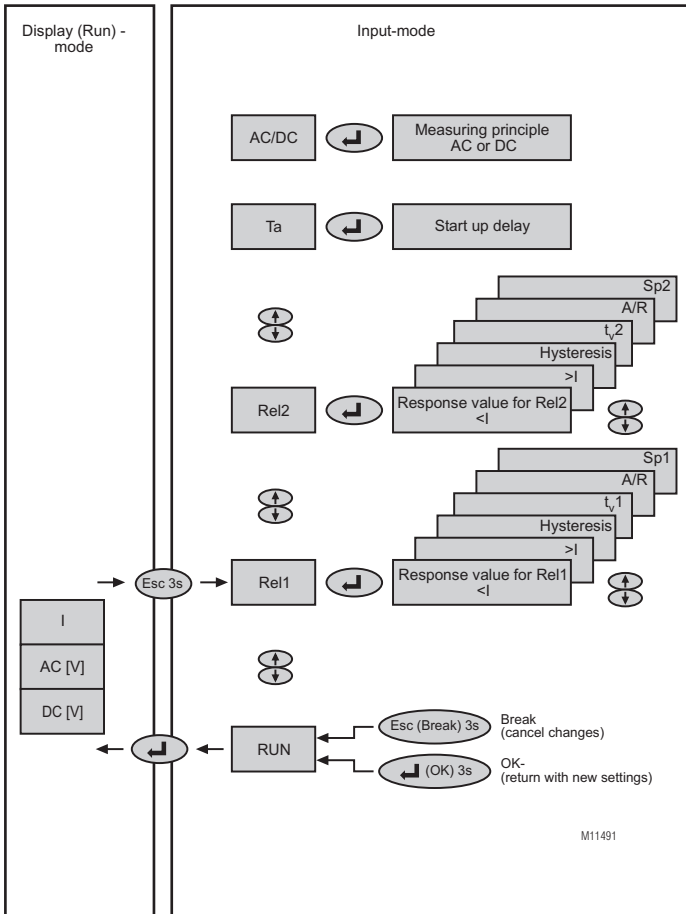

After connecting the auxiliary supply A1/A2 the unit is in **display (Run) mode**:

The actual measured value is displayed continuously (AC or DC)  
The display is inverted when a measured value is exceeds the settings..

With button the fault memory is reset.

Pressing button for more than 3 sec the unit changes to **input mode**.

In input mode the measurement is disabled, the relays are in failure mode and the indicator LED is orange.

With the buttons the different setting values can be chosen.

Move cursor position

One character to the right

One character to the left

### Back to the Display (Run)-Mode

Press button 3 s OK New values stored

or

Press button 3 s; Break Values unchanged

on the display confirm with to change to display (Run) mode.

M11491

Display (Run) - Modus	Input-Mode
Display inverted when the actual value is in failure state.	Measurement interrupted, relays are in failure state, indicator LED orange color
no function	Chose Rel1, Rel2, T <sub>a</sub> , AC/DC and RUN Chose parameter Change and set response values for Rel1 and Rel2.
Reset fault memory:	Input places-switch:  Shift cursor to the left Shift cursor to the right
For more the 3 sec, change to input mode	For more than 3 sec, change to display mode

## Technical Data

### Auxiliary voltage A1/A2

### Nominal auxiliary voltage $U_H$

MK 9063N, MH 9063:	DC 24 V	(0.9 ... 1.1 x $U_H$ )
MH 9063:	AC/DC 110 ... 400 V	(0.8 ... 1.1 x $U_H$ )
<b>Nominal frequency:</b>	50 / 60 Hz	
<b>Frequency range:</b>	45 ... 400 Hz	
<b>Input current</b>		
at DC 24 V:	50 mA	
at AC 230 V:	15 mA	

### Current Measuring Input i+/k

Measuring range	Internal resistance	Max. current
AC/DC 1 ... 20 mA	1.5 $\Omega$	0.7 A
AC/DC 4 ... 100 mA	150 m $\Omega$	2.0 A
AC/DC 20 ... 500 mA	30 m $\Omega$	5.0 A
AC/DC 0.4 ... 10 A	3 m $\Omega$	15 A

other on request

<b>Nominal frequency:</b>	50 / 60 Hz
<b>Frequency range</b>	
AC:	10 ... 400 Hz

### Setting Range (absolute, via button and LCD-display)

<b>Measuring accuracy at nominal frequency:</b>	$\pm 1\% \pm 2$ Digit
<b>Hysteresis</b> (in % of setting value):	2 ... 50 %
<b>Reaction time:</b>	< 350 ms
<b>Adjustable on delay (<math>t_d</math>):</b>	0 ... 10 sec (in steps of 0.1 sec)
<b>Adjustable start up delay (<math>t_s</math>):</b>	0.2 ... 10 sec (in steps of 0,1 sec)

### Output Circuit (Rel1: 11/12/14; Rel2: 21/22/24)

<b>Contacts:</b>		
MK 9063N:	1 changeover contact	
MH 9063:	1 changeover contact (Rel1) and 1 changeover contact (Rel2)	
<b>Thermal current <math>I_{th}</math>:</b>	2 x 4 A	
<b>Switching capacity</b> to AC 15		
NO contacts:	3 A / AC 230 V	IEC/EN 60 947-5-1
NC contacts:	1 A / AC 230 V	IEC/EN 60 947-5-1
to DC 13		
NO contacts:	1 A / DC 24 V	IEC/EN 60 947-5-1
NC contacts:	1 A / DC 24 V	IEC/EN 60 947-5-1
<b>Electrical life</b> to AC 15 at 3 A, AC 230 V:	2 x 10 <sup>5</sup> switch. cycl. IEC/EN 60 947-5-1	
<b>Permissible switching frequency:</b>	1800 / h	
<b>Short circuit strength</b>		
<b>Max. fuse rating:</b>	4 A gG / gL IEC/EN 60 947-5-1	
<b>Mechanical life:</b>	30 x 10 <sup>6</sup> switching cycles	

### General Data

<b>Nominal operating mode:</b>	continuous operation	
Temperature range:		
Operation:	- 20... + 60°C (at range 0 ... - 20°C limited function of the LCD display)	
Storage:	- 25... + 60°C	
<b>Altitude:</b>	< 2,000 m	
<b>Clearance and creepage distance</b>		
Overvoltage category:	III	
Rated impulse voltage / pollution degree:	IEC/EN 60 664-1	
MK:		
Auxiliary voltage / meas. input:	4 kV / 2	
Auxiliary voltage / contact:	6 kV / 2	
Measuring input / contact:	6 kV / 2	
MH:		
Auxiliary voltage / meas. input:	4 kV / 2 ( $U_H$ = DC 24 V)	
Auxiliary voltage / meas. input:	6 kV / 2	
Auxiliary voltage / contacts:	6 kV / 2	
Measuring input / contacts:	6 kV / 2	
Contacts 11,12,14 / 21,22,24:	4 kV / 2	

## Technical Data

### EMC

Electrostatic discharge (ESD):	8 kV (air)	IEC/EN 61 000-4-2
HF irradiation		
80 MHz ... 2.7 GHz:	20 V / m	IEC/EN 61 000-4-3
Damped oscillatory wave immunity test		
Differential mode voltage:	1 kV	IEC/EN 61 000-4-18
Common mode voltage:	2.5 kV	IEC/EN 61 000-4-18
Fast transients:	2 kV	IEC/EN 61 000-4-4
Surge voltage between		
wires for power supply:	1 kV	IEC/EN 61 000-4-5
between wire and ground:	2 kV	IEC/EN 61 000-4-5
HF-wire guided:	10 V	IEC/EN 61000-4-6
Interference suppression:	Limit value class A*)	

\*) The device is designed for the usage under industrial conditions (Class A, EN 55011).

When connected to a low voltage public system (Class B, EN 55011) radio interference can be generated. To avoid this, appropriate measures have to be taken.

### Degree of protection

Housing:	IP 40	DIN EN 60 529
Terminals:	IP 20	DIN EN 60 529
<b>Housing:</b>	thermoplastic with VO behaviour according to UL Subject 94	

### Vibration resistance:

Amplitude 0.35 mm, frequency 10 ... 55 Hz	IEC/EN 60 068-2-6
20 / 060 / 04	EN 60 068-1
	DIN 46 228-1/-2/-3/-4

### Climate resistance:

### Wire connection

### Screw terminal

### (fixed):

1 x 4 mm <sup>2</sup> solid or 1 x 2.5 mm <sup>2</sup> stranded ferruled (isolated) or 2 x 1.5 mm <sup>2</sup> stranded ferruled (isolated) or 2 x 2.5 mm <sup>2</sup> solid	
---	--

Insulation of wires or sleeve length:	8 mm
--	------

### Terminal block with screw terminals

Max. cross section:	1 x 2.5 mm <sup>2</sup> solid or 1 x 2.5 mm <sup>2</sup> stranded ferruled (isolated)
---------------------	--

Insulation of wires or sleeve length:	8 mm
--	------

### Terminal block with cage clamp terminals

Max. cross section:	1 x 4 mm <sup>2</sup> solid or 1 x 2.5 mm <sup>2</sup> stranded ferruled (isolated) 0.5 mm <sup>2</sup>
---------------------	---

Min. cross section:

Insulation of wires or sleeve length:	12 $\pm 0.5$ mm
<b>Wire fixing:</b>	Plus-minus terminal screws M3,5 box terminals with wire protection or cage clamp terminals

### Fixing torque:

<b>Mounting:</b>	DIN rail	EN 60 715
------------------	----------	-----------

### Weight:

MK 9063N:	approx. 140 g
MH 9063:	approx. 250 g

### Dimensions

### Width x height x depth:

MK 9063N:	22.5 x 90 x 99 mm
MH 9063:	45 x 90 x 99 mm

## Classification to DIN EN 50155

### Vibration and

<b>shock resistance:</b>	Category 1, Class B	IEC/EN 61 373
Ambient temperature:	T1 compliant T2, T3 and TX with operational limitations	

### Protective coating of the PCB: No

### Standard Type

MK 9063N.11 AC/DC 0.4 ... 10 A DC 24 V

- Article number: 0065457
- Measuring range: AC/DC 0.4 ... 10 mA
  - Auxiliary voltage  $U_H$ : DC 24 V
  - Output: 1 changeover contact
  - Width: 22.5 mm

MH 9063.12 AC/DC 0.4 ... 10 A AC/DC 110 ... 400 V

- Article number: 0065460
- Measuring range: AC/DC 0.4 ... 10 A
  - Auxiliary voltage  $U_H$ : AC/DC 110 ... 400 V
  - Output: 1 changeover contact (Rel1) and 1 changeover contact (Rel2)
  - Width: 45 mm

### Ordering Example

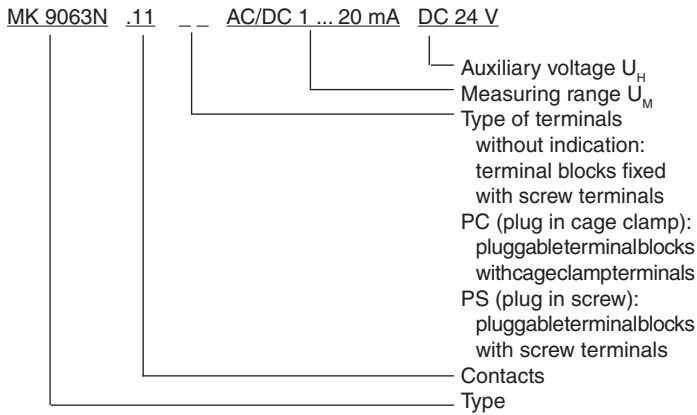

### Options with Pluggable Terminal Blocks

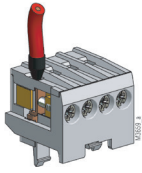

Screw terminal  
(PS/plugin screw)

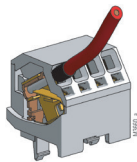

Cage clamp terminal  
(PC/plugin cage clamp)

### Notes

Removing the terminal blocks with cage clamp terminals

1. The unit has to be disconnected.
2. Insert a screwdriver in the side recess of the front plate.
3. Turn the screwdriver to the right and left.
4. Please note that the terminal blocks have to be mounted on the belonging plug in terminations.

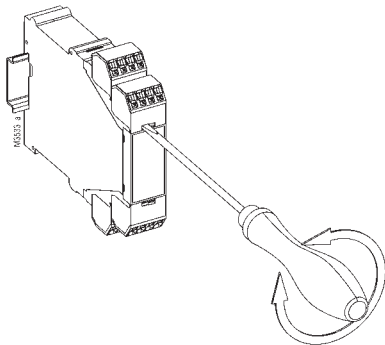

### Set Up Procedure

The connection has to be made according to the connection example.

### Safety Notes



**Dangerous voltage.**  
**Electric shock will result in death or serious injury.**



Disconnect all power supplies before servicing equipment.

- Faults must only be removed when the relay is disconnected
- The user has to make sure that the device and corresponding components are installed and wired according to the local rules and law (TUEV, VDE, Health and safety).
- Settings must only be changed by trained staff taking into account the safety regulations. Installation work must only be done when power is disconnected.
- Observe proper grounding of all components

### Connection Example

