

## VARIMETER NA

Voltage- and Frequency Monitor acc. to VDE-AR-N 4105  
RP 9810

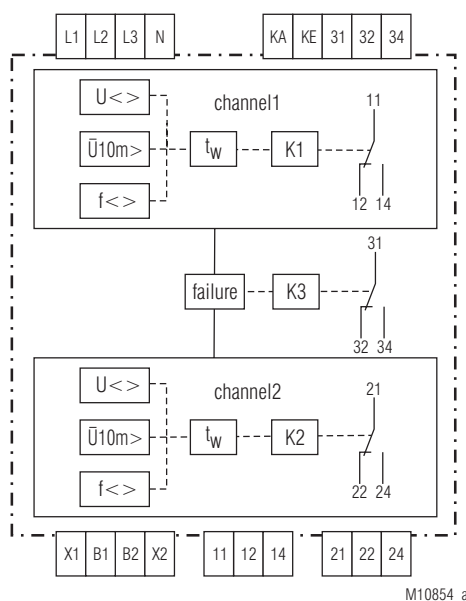

### Circuit Diagram



M10854\_a

### Connection Terminals

Terminal designation	Signal description
L1, L2, L3 / N	Auxiliary voltage and measuring inputs
11, 12, 14	Control of section switch 1
21, 22, 24	Control of section switch 2
31, 32, 34	Contacts fault signalling relay
X1, B1 / X2, B2	Enabling inputs
KA, KE	Feedback circuit of section switch

### Your Advantages

- Easy adjustment via rotational switch
- Precise adjustment and indication of setting values
- Indication, diagnostics and fault presentation via display
- Protection against manipulation by sealable transparent cover over setting switches
- Mains and system protection for your generator set

### Features

- Certificate of conformity (test certificate) of the BG ETEM acc. to VDE-AR-N 4105
- Following DIN V VDE V 0126-1-1
- According to DIN EN 60 255-1
- Can be used according to EEG 2012 and SysStabV
- Voltage and frequency monitoring for generator sets >30 kVA on public grid, as option also for ≤ 30kVA
- Fail-safe because of 2-channel structure
- Certificate of conformity (test certificate) of the BG ETEM
- Monitoring of the section switches with measuring of response time
- System test via test button
- Isolated grid detection
- Manual reset
- With additional enabling input, e.g. for ripple control receiver
- Connection or re-connection after adjustable delay time  $t_w$
- Factory setting according to VDE-AR-N 4105
- Random controlled disconnection in the range of 50.2 Hz and 51.5 Hz for non-regulated power generation systems
- Protection against manipulation by sealable transparent cover over setting switches
- Additional fault signalling relay output
- High measuring accuracy
- Installation type enclosure 4TE (width x height x depth: 70 x 90 x 71 mm)

### Approvals and Markings



### Applications

- Photovoltaic, wind power
- Combined heat and power stations, water power
- Monitoring of voltage and frequency for generator set connected to the public grid according to VDE-AR-N 4105 directive

### Functions

The voltage and frequency module RP 9810 monitors in domestic generator sets the mains of the energy supplier. It is built up in a redundant way and each of the 2 channels act on a separate output relay. The adjustment is made via rotational switches. The factory default setting is according to the description in VDE-AR-N 4105. The limit value for undervoltage is fixed at 80% of  $U_n$ . After setup the settings may be sealed with a transparent front cover.

Measured values above or below the limits will lead to a disconnection of the generator system from the mains. The reconnection of the generator system to the mains is only enabled, when the frequency and the voltage are within the limits for the adjusted time  $t_w$  without interruption. After a disconnection because of a short interruption, the reconnection is made when the frequency and the voltage are within the limits for 5 s without interruption. When the supply voltage has failed the conditions for the short interruption are not valid.

The voltage frequency monitor measures the voltage in all 3 phases between phase and neutral. In addition the phase-to-phase voltages are calculated and monitored. The frequency is measured single phase in both models in L1.

The indication of the operating status, the measured values and the fault memory is done on an LCD display. The value to be displayed is selected by pressing a pushbutton.

## Indication

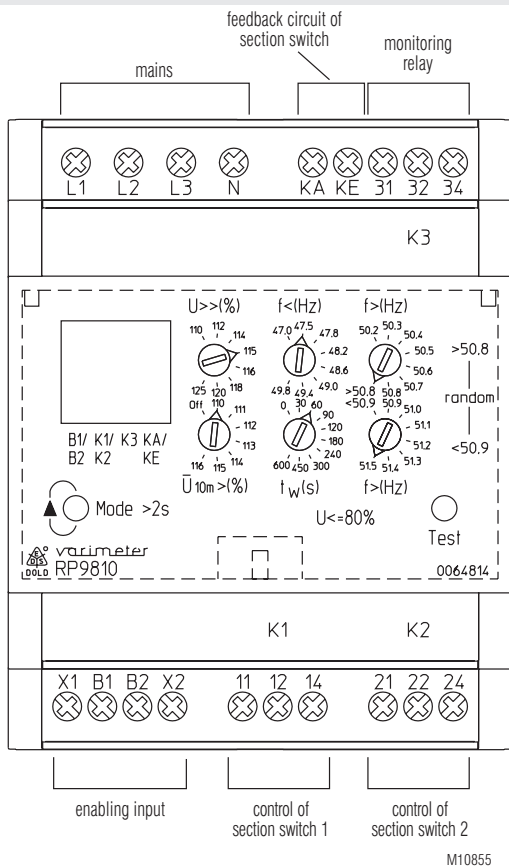

The colour of the backlight indicates the operating status of the device

- Off:** No supply voltage connected
- Green:** Normal operation.
- Red:** Failure status.
- Yellow:** Warning (failure message not acknowledged or test button pressed).

2 display modes can be selected, the actual value display and the failure memory display. Pressing the button "Mode" (>2s) toggles between both display modes.

### Actual value display

Displays the actual frequency and the voltage. Short activation of the button "mode" displays the next value.

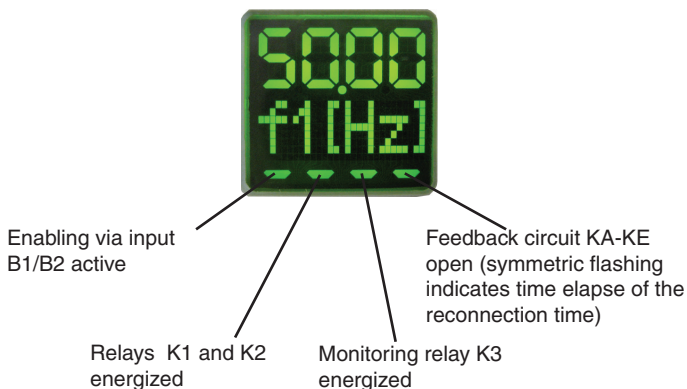

## Indication

### Display of failure memory

In failure display mode the failure entries with failure cause and relative time to event are shown. Short activation of the button "mode" displays the next failure message. If no entries are stored, the display shows "NoErr".

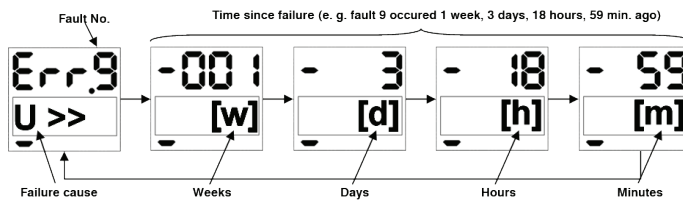

### Display of operating data (variant /\_02)

This variant displays additionally to the actual value and failure memory, the operating time or the disconnection time. Pressing the button "Mode" for more than 2 s toggles the display between actual value, failure memory and operating data.

Within this display mode the following operating data (Operational data can be selected by short actuation of the "Mode" button:

- Od.1: „T.Run“:  $\Sigma$  Operating time (powersupply connected)
- Od.2: „t.Err“:  $\Sigma$  Alarm-/ Failure duration
- Od.3: „t.Xof“:  $\Sigma$  Duration of external disconnection (via input B1/B2)

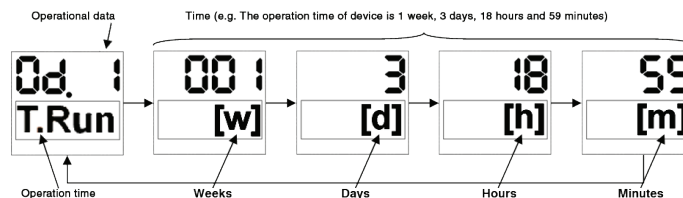

All operational data is deleted by pressing "Mode" and "Test" for more than 2 seconds in operational data display mode. The reset is confirmed on the display "ResOd" (Reset operational data).

## Error Indication

The failure status of the unit is indicated by a red backlight. If a failure is detected the unit automatically changes to failure memory display. The last 9 failures are stored, where failure 1 is the newest and failure 9 the oldest. The failures are displayed as follows

„U<“:	undervoltage
„U10m>“:	overvoltage, 10 min mean value
„U>“:	overvoltage
„f1<“:	underfrequency
„f1>“:	overfrequency
„KS“:	failure section switch (broken wire in feedback circuit KA/KE or section switch contacts welded)
„KS??“:	Warning section switch K1 and K2 energized but feedback circuit KA/KE indicates open section switch
„Setup“:	Setting of the 2 overfrequency potentiometers (f>) is not plausible
„Sys.X“:	System error
„Int.X“:	Internal error

When leaving the failure state, the backlight changes from red to yellow in the first step. Only when the failures are acknowledged, either by deleting the failure memory or by changing into display mode actual value, the backlight changes to green. The entries of the failure memory stay valid when resetting a failure message (pressing the pushbutton "Mode" for >2s).

The failure memory is deleted by pressing the buttons "Mode" and "Test" simultaneously for more than 2 seconds in display mode failure or by disconnecting the supply L1, L2, L3/N for min. 60 seconds. If a Sys.X or IntX fault cannot be reset by disconnecting the supply voltage for minimum 60 seconds, then then contact the manufacturer.

## Fault Signalling Relay

A third output relay K3 indicates the disconnection of the generator system in the case of a failure (contact 31-32).

## Isolated Grid Detection

The RP9810 includes a passive procedure to detect an isolated network according to chapter 6.5.3 and annex D2 of VDE-AR-N 4105. The 3-phase voltage monitoring allows this isolated network detection.

## System Test

With the pushbutton „Test“ the contacts of the section switch can be tested for correct function. Pressing the test button disconnects the generator system from the mains. When testing the release time of the section switch is monitored via the feedback circuit. The measured time is shown on the LCD display. To determine the full disconnection time the measuring and evaluation time is added to the release time of the section switch. According to VDE-AR-N 4105 200 ms must not be exceeded.

## Monitoring of Section Switches

Via the 2 contacts 11-14 and 21-24 the 2 section switches are controlled. The monitoring of the section switches is made by the feedback circuit (terminals KA-KE) to which the NC contacts of the section switches are connected (see connection diagrams).

The voltage and frequency monitor only connects the generator system to the mains when in disconnected state the feedback circuit KA-KE is closed, i.e. the section switches are de-energised (NC contacts are closed). As long as the section switch is not energized the feedback circuit KA-KE must be closed if not the failure "KS" is displayed.

## Random Switch Off at Overfrequency

In VDE-AR-N 4105 a frequency range between 50.2 Hz and 51.5 Hz was defined. In this range a step less reduction of the generated power can be made if the generator is controllable.

Non controllable generator systems can alternatively disconnect themselves in the frequency range of 50.2 Hz and 51.5 Hz from the mains. In this case a symmetric distribution within this range of the disconnection frequency for each plant has to be observed. The RP9810 has a random setting facility within this range, by turning both related switches into position "random". With this setting also the connection and reconnection time is automatically selected within a range of 1 ...10 minutes.

## Adjustment Facilities

Adjustment with 8-or 10 step rotary switches:

Poti 1+2 f>(Hz):	- overfrequency
Poti f<(Hz):	- underfrequency
Poti U>>(%):	- overvoltage
Poti U10m>(%):	- overvoltage, 10 min mean value
Poti t <sub>w</sub> (s):	- time delay for activation or reset
fixed:	- undervoltage

## Standard factory settings according to VDE-AR-N 4105

(not for time delay for activation):

Response value for:	- overfrequency f> = 51.5 Hz
Response value for:	- underfrequency f< = 47.5 Hz
Response value for:	- overvoltage U>> = 115 %
Response value for:	- undervoltage U< = 80 %
Response value for:	- overvoltage, 10 min mean value U10m> = 110 %
Time delay for:	- time delay for activation or reset t <sub>w</sub> = 60 s

Technical Data	
<b>Overfrequency:</b>	50.2 ... 51.5 Hz Adjustment on 2 Potis each with 8 steps in steps of 0.1 Hz Poti 2 min. + Poti 1 50.2 ... 50.8 Hz or Poti 1 max. + Poti 2 50.9 ... 51.5 Hz
<b>Random disconnection:</b>	50.2 ... 51.5 Hz setting f> "random"
<b>Underfrequency:</b>	47.0 ... 49.8 Hz setting via 8 step rotary switch 47.0; 47.5; 47.8; 48.2; 48.6; 49.0; 49.4; 49.8 Hz
<b>Overvoltage</b> at version ≤ 30 kVA: at version > 30 kVA: both versions are setting via 8 step rotary switch:	253 ... 288 V (L - N) 253 ... 288 V (L - N) + 438 ... 498 V (L - L) 110%, 112%, 114%, 115%, 116%, 118%, 120%, 125 % von U <sub>N</sub>
<b>Undervoltage</b> at version ≤ 30 kVA: at version > 30 kVA: both versions:	184V (L - N) 184V (L - N) + 319 V (L - L) 80% von U <sub>N</sub> fixed
<b>Overvoltage, 10 minute mean value:</b> at version ≤ 30 kVA: at version > 30 kVA: both versions are setting via 8 step rotary switch:	253 ... 267 V (L - N) 253 ... 267 V (L - N) + 438... 462 V (L - L) Off, 110%, 111%, 112%, 113%, 114%, 115%, 116% von U <sub>N</sub>
<b>Time delay for activation or reset:</b>	0 ... 600s setting via 10 step rotary switch 0, 30, 60, 90, 120, 180, 240, 300, 450, 600 s
<b>Random</b> <b>Random reconnection:</b>	60 ... 600 s setting f> "random"
Reconnecting conditions voltage: frequency: Repeat accuracy:	5% hysteresis 47.5 Hz ... 50.05 Hz Voltage measuring ≤ ± 1 % ± 1 digit Frequency measuring ≤ ± 0.02 % ± 1 digit
Response time (disconnection):	< 100 ms

#### Output

<b>Relay K1 and K2:</b>	1 changeover contact each
<b>relay K3:</b>	1 changeover contact
The 3 Output relays are de-energized on trip, after disconnection or failure	
<b>Thermal current I<sub>th</sub>:</b>	5 A
<b>Switching capacity</b> according to AC 15	
NO contact:	3 A / AC 230 V IEC/EN 60 947-5-1
NC contact:	1 A / AC 230 V IEC/EN 60 947-5-1
<b>Electrical life</b> to AC 15 at 1 A, AC 230 V	
NO contact:	3 x 10 <sup>5</sup> switch. cycles IEC/EN 60 947-5-1
<b>Short circuit strength</b> <b>max. fuse rating:</b>	6 A gL IEC/EN 60 947-5-1
<b>Mechanical life:</b>	> 50 x 10 <sup>6</sup> switching cycles

Technical Data	
<b>General Data</b>	
<b>Voltage range:</b>	3 x AC 85 V ... 288 V (U <sub>H</sub> of all 3-phases to neutral) AC 24V, 40 ... 400Hz
<b>Enabling inputs B1/B2:</b>	
<b>Temperature range:</b>	
Operation:	- 20 ... 60 °C (At an ambient temperature below 0°C the LCD display may have restricted function.)
Storage:	- 25 ... 70 °C
<b>Altitude:</b>	< 2.000 m
<b>Clearance and creepage distance</b>	
rated impulse voltage/ pollution degree:	
Measuring circuit / 11, 12, 14 / 21, 22, 24:	6 kV / 2 IEC 60 664-1
Measuring circuit / B1, B2 / 31, 32, 34:	4 kV / 2 IEC 60 664-1
the Measuring circuit are:	L1, L2, L3, N, KA, KE, X1, X2
<b>EMC</b>	
Electro static discharge (ESD):	8 kV (air) IEC/EN 61 000-4-2
HF irradiation	
80 MHz ... 2,7 GHz:	10 V/m IEC/EN 61 000-4-3
Fast transients:	4 kV IEC/EN 61 000-4-4
Surge voltage between wires for power supply:	2 kV IEC/EN 61 000-4-5
between wire and ground:	4 kV IEC/EN 61 000-4-5
HF wire guided:	10 V IEC/EN 61 000-4-6
interference suppression:	Limit value class B EN 55 011
<b>Degree of protection</b>	
Housing:	IP 40 IEC/EN 60 529
Terminals:	IP 20 IEC/EN 60 529
Housing:	thermoplastic with VO behaviour acc. to UL subject 94
<b>Vibration resistance:</b>	Amplitude 0.35 mm Frequenz 10...55 Hz, IEC/EN 60 068-2-6 20 / 060 / 04 IEC/EN 60 068-1 EN 50 005
<b>Climate resistance:</b>	
<b>Terminal designation:</b>	
<b>Wire connection</b>	
Cross section:	solid/stranded 0.5 ... 4 mm <sup>2</sup>
Stranded ferruled:	0.5 ... 4 mm <sup>2</sup>
Stripping length:	6.5 mm
<b>Wire fixing:</b>	Plus-minus terminal screws M3.5 box terminals
<b>Fixing torque:</b>	0.5 Nm
<b>Mounting:</b>	DIN-rail
<b>Weight:</b>	215 g
<b>Recommend fuse protection</b>	
<b>measuring inputs:</b>	gG / gL 6A
<b>Dimensions</b>	
<b>Width x height x depth:</b>	70 x 90 x 71 mm
<b>Standard Type</b>	
RP 9810.13 3/N AC 400/230V > 30 kVA	
Article number:	0064814
RP 9810.13/100 3/N AC 400/230V ≤ 30 kVA	
Article number:	0064860
<b>Variant</b>	
RP 9810.13/_ 02:	with additional display of operating data
<b>Ordering example for variant</b>	
RP 9810 .13 / _ 02 3N AC 400 / 230 V ≤ 30 kVA	

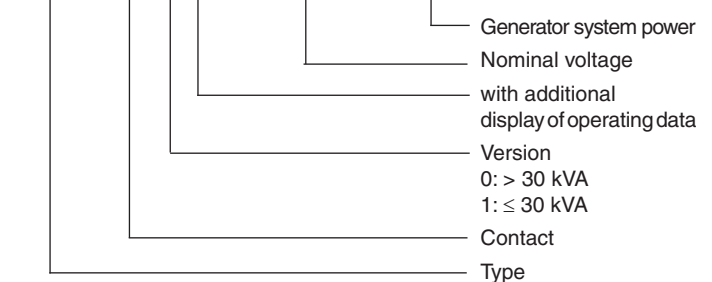

## Application Examples

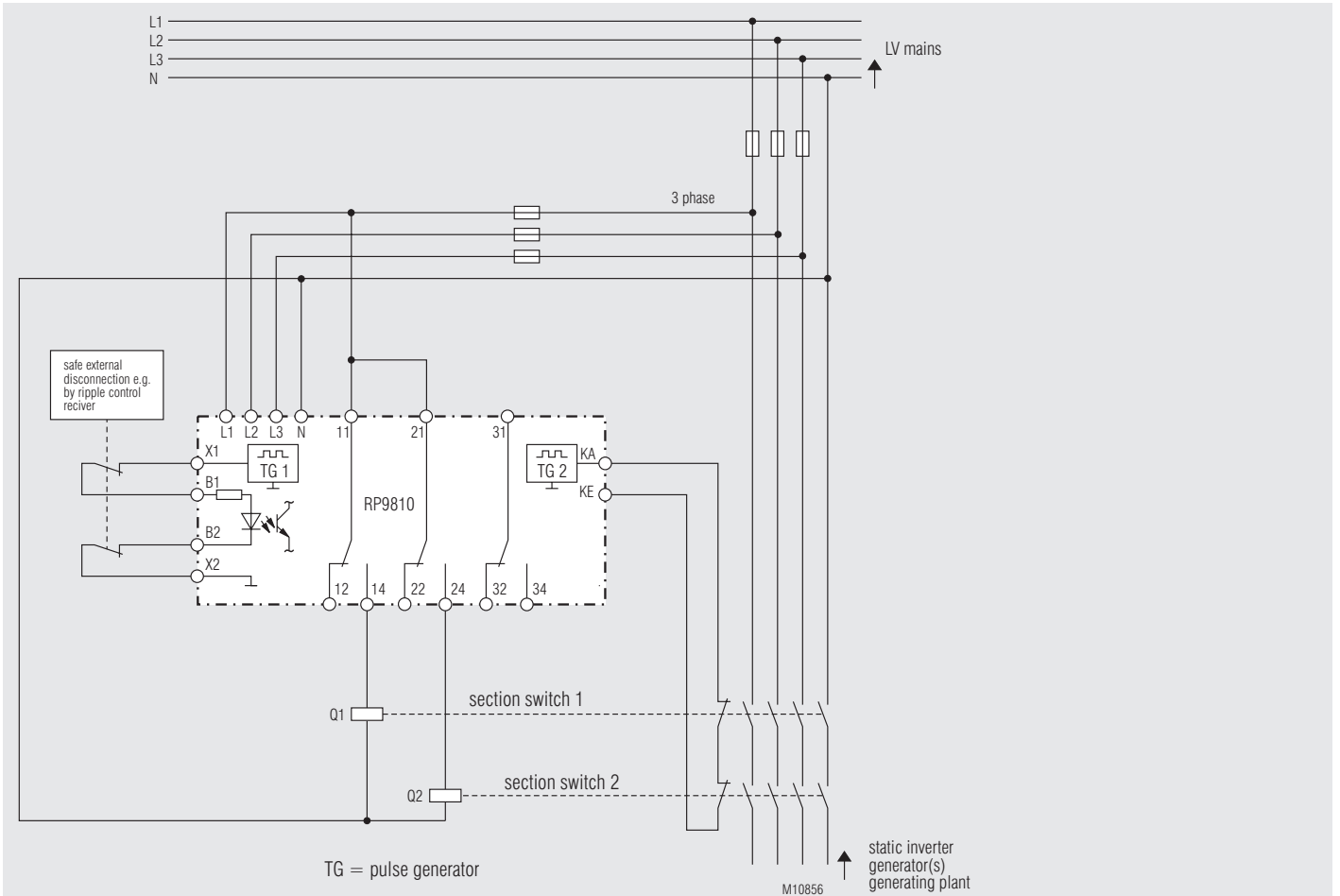

enable via external contact

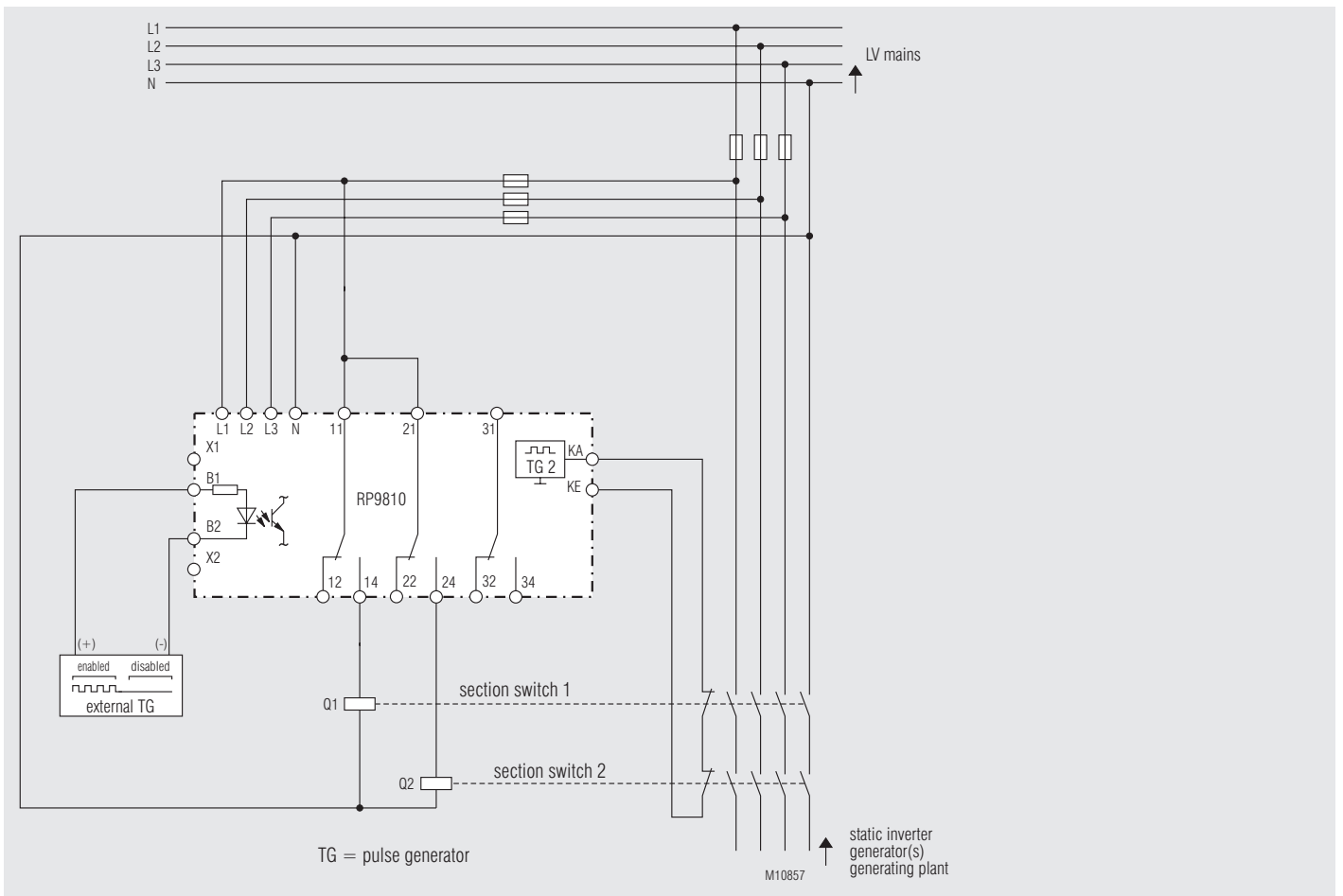

enable via external power AC 24V 40 ... 400Hz

