

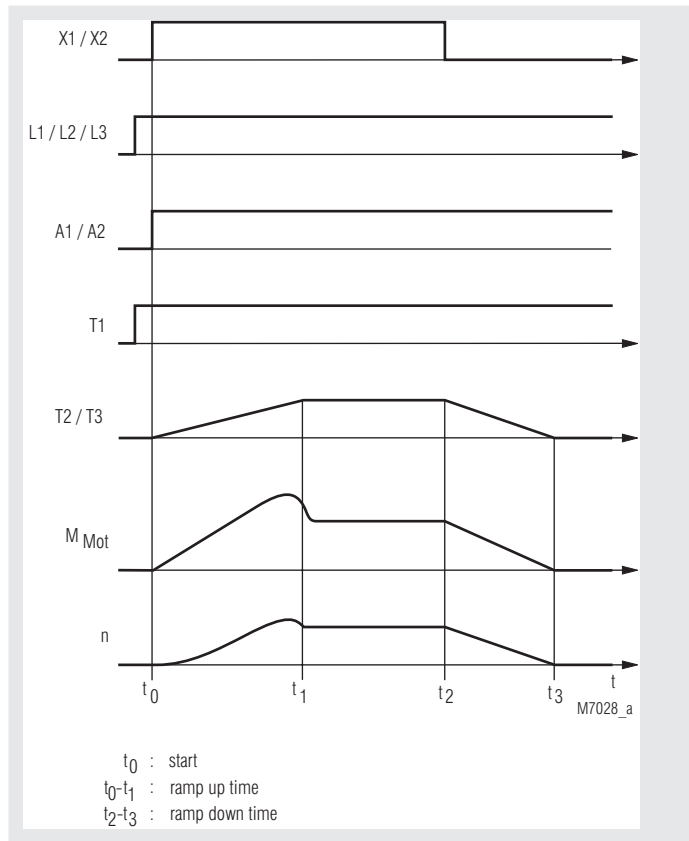

Product Description

The softstart-softstop unit provides smooth starting and stopping of 3-phase asynchronous motors. 2 phases are controlled by power semiconductors in a way that the current can rise continuously. This provides also a continuous rising motor torque. This eliminates mechanical shock while starting. After successful starting the power semiconductors are bridged with internal relay contacts. This reduces internal power dissipation. The softstop function prolongs the stop time of the motor in order to avoid a sudden stop.

Function Diagram



Your Advantages

- Simple and time-saving commissioning as well as user-friendly operation through setting via potentiometers
- Hybrid relay combines benefits of relay technology with non-wearing semiconductor technology
- High availability by
 - Temperature monitoring of semiconductors
 - High withstand voltage up to 1500 V

Features

- According to IEC/EN 60 947-4-2
- 2-phase softstart and softstop of 3-phase motors up to 4 kW
- 4 potentiometer für setting of starting torque, deceleration torque, softstart /-stop
- 3 LEDs for status indication
- Reset button on front
- Connection facility for external reset button
- Relay indicator output for operation
- Galvanic separation between control circuit and power circuit
- Width 22,5 mm

Approvals and Markings

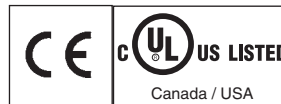

Applications

- Motors with gear, belt or chain drive
- Fans, pumps, conveyor systems, compressors
- Woodworking machines, centrifuges
- Packaging machines, door drives
- Start current limiting on 3 phase motors

Circuit Diagram

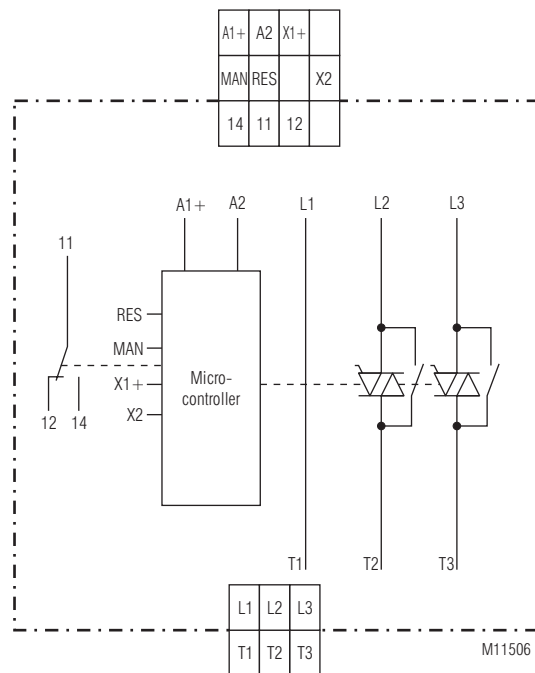

Connection Terminals

Terminal designation	Signal description
A1 (+)	Auxiliary voltage + DC 24 V
A2	Auxiliary voltage 0 V
X1+	Control input Start/Stop
X2	Earth connection control input
MAN	Input for remote reset
RES	Output for remote reset
11, 12, 14	Indicator relay for operation
L1	Phase voltage L1
L2	Phase voltage L2
L3	Phase voltage L3
T1	Motor connection T1
T2	Motor connection T2
T3	Motor connection T3

Function

Soft start

Two motor phases are impacted through thyristor phase-fired control to allow a steady increase of the currents. The motor torque behaves in the same manner when ramping up. This ensures that the drive can start without jerking and the drive elements are not damaged. Starting time and starting torque can be adjusted via rotary switch t_{on} and M_{on} .

Softstop

The softstop function shall extend the natural running down time of the drive to also prevent jerky stopping.

The deceleration time is set with rotary switch t_{off} , the running-down torque with rotary switch M_{off} .

Phase failure

To make sure the motor is not loaded with asymmetric currents, a check takes place during motor start whether phases L1, L2 and L3 are present. If one or several phases are absent, the device switches to fault 4. The fault can be acknowledged via the reset button or reset input.

Control inputs

If a voltage of more than 10 V DC is connected to terminals X1/X2, the device begins with softstart. If the voltage falls lower than DC 8 V the device will softstop.

Signalling output "Ready"

Contact 11/14 is closed if no device fault is present.

Indication

green LED "ON": permanent on	- auxiliary supply connected
yellow LED "RUN": permanent on	- power semiconductors bridged
flashing	- ramp operation
red LED "ERROR": flashing	- Error
1*)	- Overtemperature on semiconductors
2*)	- Wrong mains frequency
3*)	- Phase reversal detected
4*)	- min. 1 phase is missing
7*)	- Incorrect temperature measurement circuit

1*) - 7*) = Number of flashing pulses in sequence

Reset Function

2 options are available to acknowledge the fault

Manual (reset button):

Acknowledgement is performed by operating the reset button at the front of the device. If the button is still actuated after 2 seconds, the device resumes the fault state.

Manual (remote acknowledgement):

Remote acknowledgement can be realised by connecting a button (N/O contact) between the terminals MAN and RES. Acknowledgement is triggered as soon as the contact of the button closes. If the button is still actuated after 2 seconds, the device resumes the fault state since a defect in the acknowledgement circuit cannot be ruled out.

Setting

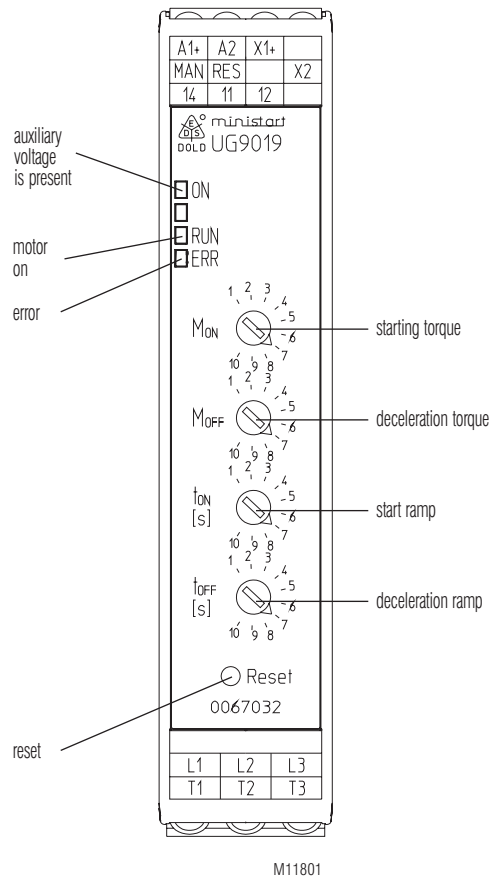

Setting Facilities

Rotary switch M_{on} :	- Starting torque at softstart 30 ... 80 %
Rotary switch M_{off} :	- Deceleration torque at softstop 80 ... 30 %
Rotary switch t_{on} :	- Start ramp 1 ... 10 s
Rotary switch t_{off} :	- Deceleration ramp 1 ... 10 s

Set-up Procedure

1. Connect motor and device according to application example. A clockwise rotating field is assumed for operation. A anti-clockwise rotating field triggers a fault message
2. Turn rotary switch t_{on} / t_{off} fully clockwise, M_{on} e. g. M_{off} fully anticlockwise and rotary switch I_{max} e. g. I_g of the required current.
3. Connect voltage and starting via input R- or softstop L-.
4. The starting time is set by turning the rotary switch t_{on} anti-clockwise and the starting torque is set by turning the rotary switch M_{on} clockwise to the desired value. If set correctly, the motor shall swiftly accelerate to the nominal speed.

Safety Notes

Attention !



- Never clear a fault when the device is switched on.
- The user must ensure that the device and the necessary component are mounted and connected according to the locally applicable regulations and technical standards (VDE, TÜV, BG)
- Adjustments may only be carried out by qualified specialist staff and the applicable safety rules must be observed.
- After a short circuit the softstart-softstop unit is defective and has to be replaced (Assignment type 1).
- Group supply:
- If several softstart-softstop units are protected together, the sum of the motor currents must not exceed 25 A.

Technical Data

Nominal voltage L1/L2/L3:	3 AC 200 ... 480 V ± 10 %
Nominal frequency:	50 / 60 Hz , automatic detection
Auxiliary voltage:	DC 24 V ± 10 %
Motor power:	max. 4 kW at AC 400 V
Min. motor power:	50 W
Operating mode:	
6.9 A (3 kW / 400 V):	AC 53a: 3-5: 100-30 IEC/EN 60947-4-2
9 A (4 kW / 400 V):	AC 53a: 6-2: 100-30 IEC/EN 60947-4-2
Surge current:	200 A (tp = 20 ms)
Load limit integral:	200 A ² s (tp = 10 ms)
Peak reverse voltage:	1500 V
Overvoltage limiting:	AC 550 V
Leakage current in off state:	< 3 x 0.5 mA
Starting voltage:	30 ... 80 %
Start / deceleration ramp:	1 ... 10 s
Consumption:	2 W
Start up delay for master tick:	max. 100 ms
Release delay for master tick:	max. 50 ms
Short circuit strength:	
max. fuse rating:	25 A gG / gL IEC/EN 60 947-5-1
Assignment type:	1
Electrical life:	> 10 x 10 ⁶ switching cycles

Inputs

Control input X1+/X2:	DC 24 V
Rated current:	4 mA
Response value ON:	DC 15 V ... 30 V
Response value OFF:	DC 0 V ... 5 V
Connection:	polarity protected diode
Manual:	DC 24 V (connect button on terminals "MAN" and "RES")

Indicator Outputs

RES:	DC 24 V, semiconductor, short circuit proof, rated continuous current 0.2 A
Ready:	Changeover contact 250 V / 5 A
Contact:	1 changeover contact
Switching capacity to AC 15	
NO contact:	3 A / AC 230 V IEC/EN 60 947-5-1
NC contact:	1 A / AC 230 V IEC/EN 60 947-5-1
Thermal current I_{th}:	5 A
Electrical life to AC 15 at 3 A, AC 230 V:	2 x 10 ⁵ switch. cycles IEC/EN 60 947-5-1
Mechanical life:	30 x 10 ⁶ switching cycles
Permissible switching frequency:	1800 switching cycles/h
Test voltage	
Coil - Contact:	4000 V AC
Open Contact:	1000 V AC
Short circuit strength	
max. fuse rating:	4 A gG / gL IEC/EN 60 947-5-1

Technical Data

General Data

Device type:	Hybrid Motor Controller H1B
Operating mode:	Continuous operation
Temperature range:	
Operation:	0 ... + 60 °C (see derating curve)
Storage:	- 25 ... + 75 °C
Relative air humidity:	93 % at 40 °C
Altitude:	< 1.000 m
Clearance and creepage distances	
Rated insulation voltage:	500 V
overvoltage category / contamination level	
between control input- , auxiliary voltage and Motor voltage respectively	
indicator contact:	4 kV / 2 IEC/EN 60 664-1
Overvoltage category:	III
EMC	
Interference resistance	
Electrostatic discharge (ESD):	8 kV (air) IEC/EN 61 000-4-2
HF-irradiation	
80 MHz ... 1.0 GHz:	10 V / m IEC/EN 61 000-4-3
1.0 GHz ... 2.5 GHz:	3 V / m IEC/EN 61 000-4-3
2.5 GHz ... 2.7 GHz:	1 V / m IEC/EN 61 000-4-3
Fast transients:	2 kV IEC/EN 61 000-4-4
Surge voltage between	
wires for power supply:	1 kV IEC/EN 61 000-4-5
between wire and ground:	2 kV IEC/EN 61 000-4-5
HF-wire guided:	10 V IEC/EN 61 000-4-6
Voltage dips:	IEC/EN 61 000-4-11
Interference emission	
Wire guided:	Limit value class B IEC/EN 60 947-4-2
Radio irradiation:	Limit value class B IEC/EN 60 947-4-2
Degree of protection:	
Housing:	IP 40 IEC/EN 60 529
Terminals:	IP 20 IEC/EN 60 529
Vibration resistance:	Amplitude 0.35 mm frequency 10 ... 55 Hz, IEC/EN 60 068-2-6 0 / 060 / 04 IEC/EN 60 068-1 DIN 46 228-1/-2/-3/-4
Climate resistance:	
Wire connection:	
Screw terminal (fixed):	
Control terminals	
Cross section:	1 x 0.14 ... 2.5 mm ² solid or stranded wire with sleeve
Power terminals	
Cross section:	1 x 0.25 ... 2.5 mm ² solid or stranded wire with sleeve
Insulation of wires or sleeve length:	8 mm
Fixing torque:	0.5 Nm
Wire fixing:	captive slotted screw
Mounting:	DIN rail IEC/EN 60 715
Weight:	220 g
Dimensions	
Width x height x depth:	22.5 x 105 x 120.3 mm

UL-Data

Standards:

for all products:

- U.S. National Standard UL508, 17th Edition
- Canadian National Standard - CAN/CSA-22.2 No. 14-13, 12th Edition

with restrictions at motor switching power:

- ANSI/UL 60947-1, 3rd Edition (Low-Voltage Switchgear and Controlgear Part 1: General rules)
- ANSI/UL 60947-4-2, 1st Edition (Low-Voltage Switchgear and Controlgear Part 4-2: Contactors and Motor-Starters - AC Semiconductor Motor Controllers and Starters)
- CAN/CSA-C22.2 No. 60947-1-07, 1st Edition (Low-Voltage Switchgear and Controlgear - Part 1: General rules)
- CSA-C22.2 No. 60947-4-2-14, 1st Edition (Low-Voltage Switchgear and Controlgear - Part 4-2: Contactors and Motor-Starters - AC Semiconductor Motor Controllers and Starters)

Motor data:

UL 508, CSA C22.2 No. 14-13

3 AC 200 ... 480 V,

3-phase, 50 / 60 Hz:

up to 7.6 FLA, 45.6 LRA at 40 °C
up to 4.8 FLA, 28.8 LRA at 50 °C
up to 2.1 FLA, 12.6 LRA at 60 °C

UL 60947-4-2, CSA 60947-4-2

3 AC 200 ... 300 V,

3-phase, 50 / 60 Hz:

up to 7.6 FLA, 45.6 LRA at 40 °C
up to 4.8 FLA, 28.8 LRA at 50 °C
up to 2.1 FLA, 12.6 LRA at 60 °C

3 AC 301 ... 480 V,

3-phase, 50 / 60 Hz:

up to 2.1 FLA, 12.6 LRA at 60 °C

Indicator output relay:

5A 240Vac Resistive

Wire connection:

60°C / 75°C copper conductors only

Connections

A1+, A2, X1+, X2, MAN,
RES, NE, 11, 12, 14:

AWG 22 - 14 Sol/Str Torque
3.46 Lb-in (0.39 Nm)

L1, L2, L3, T1, T2, T3:

AWG 30 - 12 Str Torque 5-7 Lb-in
(0.564-0.79 Nm)

Additional Notes:

- This device is intended for use on supply systems with a maximum voltage from phase to ground of 300V (e.g. for a three phase-four wire system 277/480 V or on a three phase-three wire systems of 240V), rated impulse withstand voltage of max. 4 kV
- Suitable for use on a circuit capable of delivering not more than 5000 rms symmetrical Amperes, 480 Volts maximum when protected by class CC, J or RK5 fuse rated maximum 20 A
- For use in pollution degree 2 Environment or equivalent
- The control circuits of this device shall be supplied by an isolated 24 Vdc power supply which output is protected with a fuse rated max. 4 A dc
- For installations according to Canadian National Standard C22.2 No. 14-13 (cUL Mark only) and supply voltages above 400V:
 - Transient surge suppression devices shall be installed on the line side of this equipment and shall be rated 240 V (phase to ground), 415 V (phase to phase), suitable for overvoltage category III, and shall provide protection for a rated impulse withstand voltage peak of 4 kV
 - Transient surge suppression devices shall be installed on the line side of this equipment and shall be rated 277 V (phase to ground), 480 V (phase to phase), suitable for overvoltage category III, and shall provide protection for a rated impulse withstand voltage peak of 4 kV



Technical data that is not stated in the UL-Data, can be found in the technical data section.

Characteristics

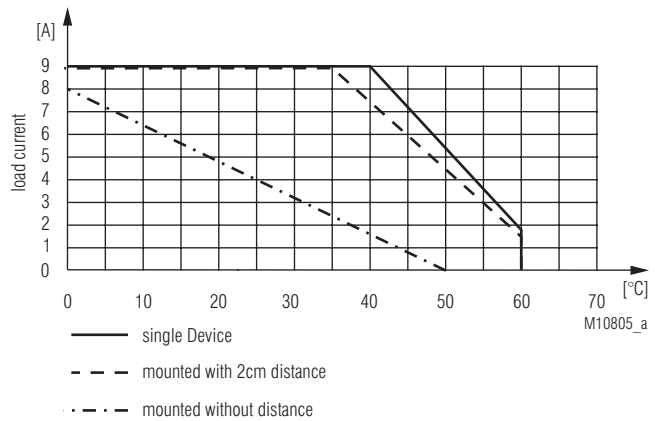

Derating curve:

Rated continuous current depending on ambient temperature and distance
Enclosure without ventilation slots

Standard Type

UG 9019.11/110/61 3 AC 200 ... 480 V 9,0 A 1 ... 10 s

Article number: 0067032

• Nominal voltage: 3 AC 200 ... 480 V

• Nominal current: 9,0 A

• Ramp time: 1 ... 10 s

• Width: 22.5 mm

Ordering Example

UG 9019 .11 /110 /61 3 AC 200 ... 480 V 9,0 A 1 ... 10 s

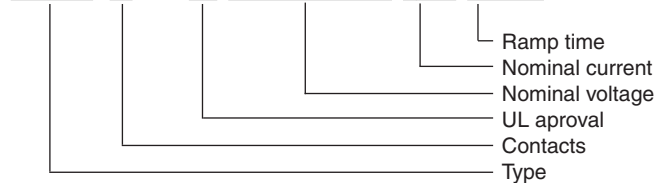

Application Example

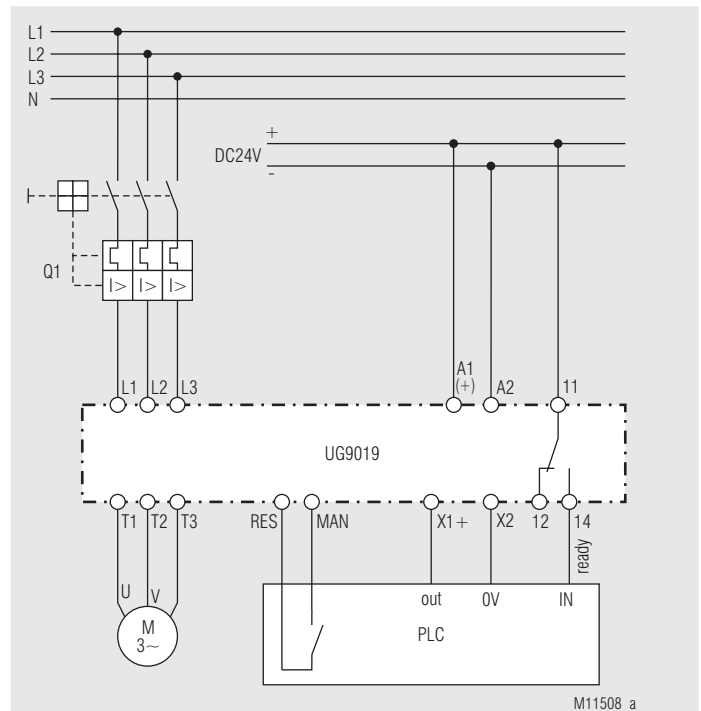

Motor control with UG 9019 and PLC