

POWERSWITCH
Semiconductor Relay / - Contactor
PH 9260

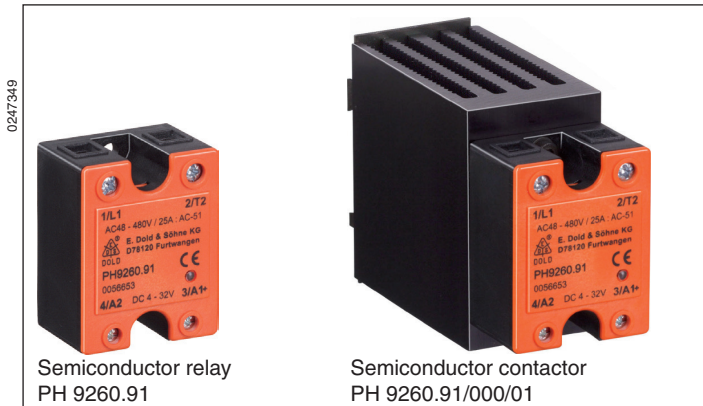

0247349

- AC semiconductor relay / -contactor
- According to IEC/EN 60947-4-3
- Load current up to 125 A, AC 51 with I²t up to 18000 A²s
- Switching at zero crossing
- As option switching at voltage maximum
- 2 anti-parallel thyristors
- DCB technology (direct bonding method) for excellent heat transmission properties
- Touch protection IP20
- Box terminals
- LED status indicator
- Peak reverse voltage 1200 V or 1600 V
- Insulation voltage 4000 V
- As option with overtemperature protection
- As option with reduced HF-emission
- As option with heat sink, for DIN rail mounting
- Width: 45 mm

Function Diagram

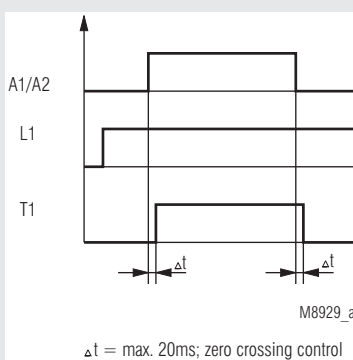

Approvals and Markings



Applications

Solid state relays switching at zero crossing:

For frequent no-wear and no-noise switching of

- heating systems
- motors
- valves
- lighting systems

The semiconductor relay switches at zero crossing and is suitable for many applications e.g. extrusion machines for plastic and rubber, packaging machines, solder lines, machines in food industry.

Solid state relays switching at voltage maximum:

he solid state relay PH 9260/020 switching at voltage maximum is suitable to switch transformers. The usual high inrush current does not occur.

Circuit Diagram

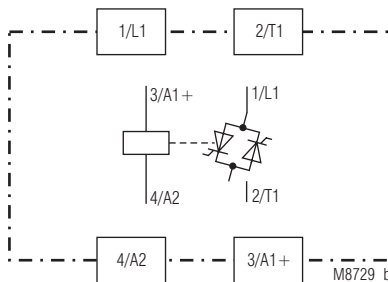

PH 9260.91

Function

The semiconductor relay PH 9260 is designed with 2 anti-parallel connected thyristors switching at zero crossing.

When connecting the control voltage the output of the semiconductor relay is activated at the next zero crossing of the sinusoidal voltage. When disconnecting the control voltage the output is switched off at the next zero crossing of the load current.

The LED shows the state of the control input.

As option the semiconductor relay is available with heatsink to be mounted on DIN rail. This provides optimum heat transmission.

Notes

Overtemperature protection

Optionally, the semiconductor relay has an overtemperature protection to monitor the temperature of the heat sink. To this end, a thermal release switch (NC contact) can be inserted into the respective pocket at the bottom of the semiconductor relay. As soon as the temperature of the heat sink exceeds for example 100°C, the thermal release switch. For thermal protection of the semiconductor relay, a thermal release switch of UCHIYA type UP62 – 100 can be installed.

Technical Data

Output

Load voltage AC [V]:

PH 9260: 24 ... 240, 48 ... 480, 48 ... 600

PH 9260/020: 100 ... 240, 200 ... 480

Frequency range [Hz]: 47 ... 63

Load current [A], AC-51:

PH 9260, PH 9260/020: 25 50 100¹⁾ 125¹⁾

Load current [A], AC-56a:

PH 9260/020: 10 20 - -
- 30³⁾ - -

Load limit integral I²t [A²s]:

800 1800 6600²⁾ 6600 18000

Max. overload current [A]

t = 10 ms: 400 600 1150²⁾ 1150 1900

Periodic overload current

t = 1 s [A]: 40 120 150²⁾ 150 200

Min. current [mA]:

20

On-state voltage
at nominal current [V]:

1.2 1.4 1.4 1.3

Rate of rise of
off-state voltage [V/μs]:

500 500 1000 1000

Rate of rise of current [A/μs]:

100 100 100 150

Temperature Data

Thermal resistance
junction - housing [K/W]:

0.6 0.5 0.3 0.3

Thermal resistance
housing - ambient [K/W]:

12 12 12 12

Junction temperature [°C]:

≤ 125

¹⁾ Only for pulse operation: Please make sure, that the mean value of the current does not exceed 50 A on these devices.

²⁾ Variant PH 9260.91/1_ _

³⁾ Variant PH 9260.91/120

Control Circuit

	DC	AC/DC	AC/DC
Control voltage range [V]:	4 ... 32	18 ... 36	100 ... 240
Max. nominal input current [mA]: PH 9260:	12	25 (AC) 12 (DC)	5 bei 240 V AC (regulated)
Max. nominal input current [mA]: PH 9260/020:	20	-	-
Turn-on delay [ms]:	5 + 1/2 cycle		
Turn-off delay [ms] at AC/DC 18 ... 36 V:	20 + 1/2 cycle		
at AC/DC 85 ... 265 V:	30 + 1/2 cycle		

Technical Data

General Data

Operating mode: Continuous operation

Temperature range:

operation: - 20 ... 40° C

storage: - 20 ... 80° C

Clearance and creepage distances

rated impulse voltage /

pollution degree: 6 kV / 3 IEC/EN 60 664-1

EMC: IEC/EN 61 000-6-4, IEC/EN 61 000-4-1

Electrostatic discharge (ESD): 8 kV air / 6 kV contact IEC/EN 61 000-4-2

HF irradiation: 10 V / m IEC/EN 61 000-4-3

Fast transients: 2 kV IEC/EN 61 000-4-4

Surge voltages

between

wires for power supply: 1 kV IEC/EN 61 000-4-5

between wire and ground: 2 kV IEC/EN 61 000-4-5

HF-wire guided 10 V IEC/EN 61 000-4-6

Interference suppression:

Limit value class A*)

*) The device is designed for the usage under industrial conditions (Class A, EN 55011).

When connected to a low voltage public system (Class B, EN 55011) radio interference can be generated. To avoid this, appropriate measures have to be taken.

Degree of protection

Housing: IP 40 IEC/EN 60 529

Terminals: IP 20 IEC/EN 60 529

Vibration resistance:

Amplitude 0.35 mm

frequency 10 ... 55 Hz, IEC/EN 60-068-2-6

Housing material: Fiberglass reinforced polycarbonate

Flame resistant: UL 94 V0

Aluminum, copper nickle-plated

Base plate:

Potting compound:

Polyurethane

Mounting screws:

M5 x 8 mm

Fixing torque:

2.5 Nm

Connections control circuit:

Mounting screws M3 Pozidrive 2 PT

Fixing torque:

0.5 Nm

Wire cross section:

1.5 mm² wire

Connections load circuit:

Mounting screws M4 Pozidrive 1 PT

Fixing torque:

1.2 Nm

Wire cross section:

10 mm² wire

Nominal insulation voltage

Control circuit – load circuit:

4 kV_{eff.}

Load circuit – base plate:

4 kV_{eff.}

Overvoltage category:

II

Weight

without heat sink:

approx. 120 g

PH 9260.91/_ _ _ /01:

approx. 550 g

PH 9260.91/_ _ _ /02:

approx. 670 g

Dimensions

Width x height x depth

without heat sink: 45 x 58 x 32 mm

PH 9260.91/_ _ _ /01: 45 x 80 x 124 mm

PH 9260.91/_ _ _ /02: 45 x 100 x 124 mm

UL-Data

Control voltage: DC 4 ... 32 V, Class 2 or current / voltage limiting acc. to UL 508

Load type: Resistive

Wire connection:

Copper conductors only

3A1+ / 4A2: AWG 18 - 14 Torque 0.5 Nm (4.4 lb-in)

1L1 / 2T1: AWG 16 - 8 Torque 1.2 Nm (10.6 lb-in)

The load current printed on the device applies to an ambient temperature of 40 °C (104 °F).



Technical data that is not stated in the UL-Data, can be found in the technical data section.

Contents of Article Numbers

Type		PH 9260							
Variant (Designation)		Standard	PH 9260/000/01 with heat sink	Standard	PH 9260/000/02 with heat sink	PH 9260/100 (I ² t = 6600 A ² s)	PH 9260/100/02 (I ² t = 6600 A ² s with heat sink)	Standard	Standard
Load current		25 A	25 A	50 A	50 A ³⁾	50 A	50 A ³⁾	100 A	125 A
Load voltage	Control voltage								
24 ... 240 V AC	4 ... 32 V DC	0056651	0056953	0056652	0056954	0057699	0058195	0056821	0059736
	18 ... 36 V AC/DC	0063505	0063676	*	*	*	*	*	*
	100 ... 240 V AC/DC	0061422	0058255	0059749	0058256	*	*	0059631	*
48 ... 480 V AC	4 ... 32 V DC	0056653	0056955	0056654	0056956	0057700	0058196	0056822	0059737
	18 ... 36 V AC/DC	*	*	*	*	*	*	*	*
	100 ... 240 V AC/DC	0059690	0061943	0059691	0059074	*	*	0063193	*
48 ... 600 V AC	4 ... 32 V DC	0058676	*	*	0059980	0058678	*	0058677	*
	18 ... 36 V AC/DC	*	*	0058958	*	0058960	*	*	*
	100 ... 240 V AC/DC	*	*	0058959	*	0058961	*	*	*

At devices without heatsink the necessary heatsink has to be chosen according to the dimensioning notes.

* On request

Units with UL-Approval

³⁾ for stepping operation with 80 % ED

Standard Type

- PH 9260.91 AC 48 ... 480 V 50 A DC 4 ... 32 V
 Article number: 0056654
 • Load voltage: AC 48 ... 480 V
 • Load current: 50 A
 • Control voltage: DC 4 ... 32 V
 • Width: 45 mm

Variants

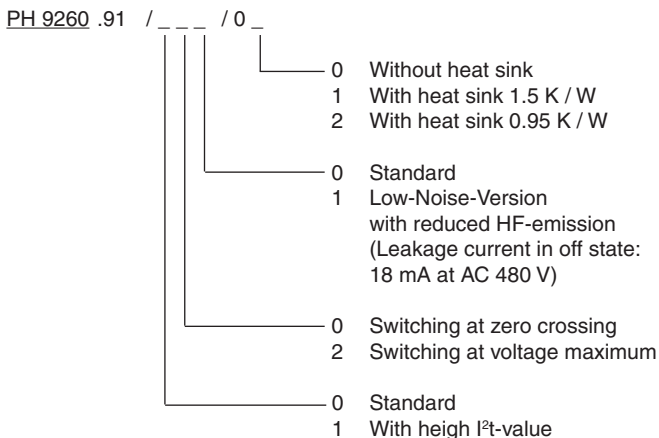

Dimensions

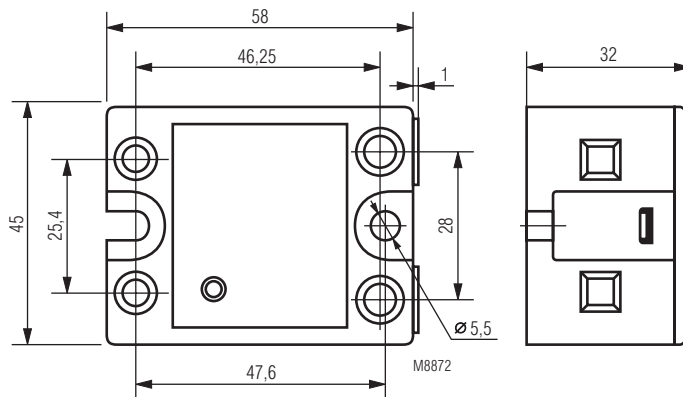

Accessories

PH 9260-0-12: Graphite foil 55 x 40 x 0.25 mm to be fitted between device and heat sink, for better heat transmission
 Article number: 0058395

For the 100 A- and 125 A-variants we recommend a 25 mm² adapter terminal type 802/115S, Brand FTG.

Ordering example for variants

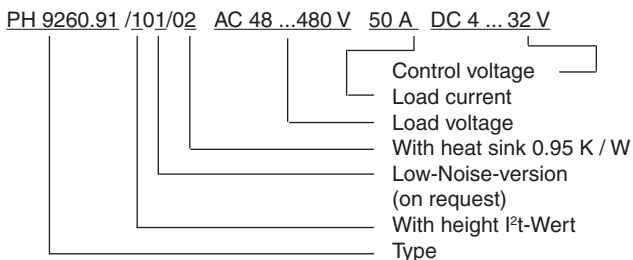

Selection of a Heat Sink

Load current (A)	PH 9260 25 A					
	Thermal resistance (K/W)					
25.0	2.8	2.5	2.1	1.8	1.5	1.1
22.5	3.2	2.8	2.5	2.1	1.7	1.3
20.0	3.7	3.3	2.8	2.4	2.0	1.6
17.5	4.3	3.8	3.4	2.8	2.4	1.9
15.0	5.1	4.6	4.0	3.5	2.9	2.4
12.5	6.3	5.6	5.0	4.3	3.6	2.8
10.0	8.0	7.2	6.4	5.6	4.7	3.9
7.5	11.0	9.9	8.7	7.6	6.5	5.4
5.0	16.8	15.0	13.5	12.0	10.0	8.5
2.5	-	-	-	-	21.0	17.6
	20	30	40	50	60	70
	Ambient-temperature (°C)					

Load current (A)	PH 9260 50 A					
	Thermal resistance (K/W)					
50	0.9	0.7	0.6	0.4	0.3	-
45	1.0	0.9	0.7	0.5	0.4	0.2
40	1.2	1.0	0.9	0.7	0.5	0.3
35	1.5	1.3	1.0	0.9	0.7	0.5
30	1.9	1.6	1.4	1.1	0.9	0.7
25	2.4	2.0	1.8	1.5	1.2	0.9
20	3.0	2.7	2.4	2.0	1.9	1.3
15	4.4	3.9	3.4	2.9	2.5	2.0
10	6.9	6.0	5.4	4.7	4.0	3.3
5	14.0	12.9	11.5	10.0	8.6	7.2
	20	30	40	50	60	70
	Ambient-temperature (°C)					

Load current (A)	PH 9260 100 A					
	Thermal resistance (K/W)					
100	0.43	0.35	0.25	0.2	-	-
90	0.56	0.46	0.35	0.28	0.2	-
80	0.7	0.6	0.5	0.4	0.3	0.2
70	0.9	0.8	0.65	0.55	0.4	0.3
60	1.2	1.0	0.9	0.75	0.6	0.46
50	1.6	1.4	1.2	1.0	0.85	0.6
40	2.3	2.0	1.8	1.5	1.2	1.0
30	3.4	3.0	2.5	2.2	2.0	1.5
20	5.6	5.0	4.5	3.9	3.3	2.7
10	12.0	11.0	10.0	9.0	7.6	6.0
	20	30	40	50	60	70
	Ambient-temperature (°C)					

Load current (A)	PH 9260 125 A					
	Thermal resistance (K/W)					
125	0.5	0.4	0.3	0.2	0.1	0.1
112.5	0.6	0.5	0.4	0.3	0.2	0.1
100	0.7	0.6	0.5	0.4	0.3	0.2
87.5	0.9	0.8	0.7	0.5	0.4	0.3
75	1.0	1.0	0.9	0.7	0.6	0.5
62.5	1.5	1.4	1.1	1.0	0.8	0.7
50	2.0	1.8	1.6	1.3	1.1	0.9
37.5	3.0	2.6	2.3	2.0	1.7	1.4
25	4.7	4.2	3.5	3.0	2.8	2.3
12.5	10.2	9.0	8.0	7.0	6.0	5.0
	20	30	40	50	60	70
	Ambient-temperature (°C)					

Notes on Sizing for Selection of a Heat Sink

The heat generated by the load current must be dissipated by a suitable heat sink. It is imperative that the junction temperature of the semiconductor is maintained for all potential environmental temperatures of under 125°C. For this reason, it is important to keep the thermal resistance between the base plate of the semiconductor relay and the heat sink to a minimum.

To protect the semiconductor relay effectively from excess heating, a thermally conducting paste should be applied before installation to the base plate of the heat sink between semiconductor relay and heat sink.

From the tables below, select a suitable heat sink with the next lowest thermal resistance. Thus, it is ensured that the maximum junction temperature of 125°C is not exceeded. The load current in relation to the environmental temperature can be seen from the table.

Application Examples

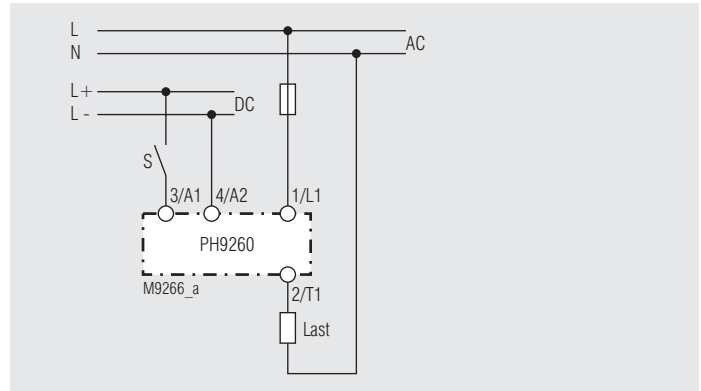

General Information

The service life and long-time reliability of a solid-state relay depends on its installation and use. Load type, load current, switching frequency, mains voltage and ambient temperature must be taken into account during the project design. To ensure the reliable operation of the devices, an exact analysis of the application and a calculation of the heat sink must be conducted in advance. Solid-state relays constantly produce heat during operation. The ambient conditions therefore require special attention. The choice of the correct heat sink is especially important since the constant overtemperature significantly reduces the service life of the devices. The use of a temperature switch is recommended if neither the load conditions nor the ambient temperatures are known. This switch is available as accessory and is inserted in a pocket on the bottom side.

Attention: The load output is not electrically separated from the mains even if no drive is present

Overload protection (Fig. 1)

The solid-state relay must be protected against short circuit by a separate solid-state fuse of coordination type 2. Choosing the I_{2t} value (switch-off integral) of the fuse half as large as the I_{2t} value of the semiconductor is recommended.

Overvoltage protection (Fig. 1)

Although the solid-state relays can withstand high peak voltages, it is better to switch an external varistor parallel to the load output. This is particularly recommended when switching inductive loads. The varistor voltage must be selected appropriate for the mains voltage. A wrong selection can create hazardous situations. As an option, the varistor is factory-installed.

Assembly on the heat sink (Fig. 2, Fig. 3)

A small amount of silicon-containing heat transfer compound is to be applied to the base plate to ensure a good thermal bond between solid-state relay and heat sink. As an alternative, a graphite foil can be placed between solid-state relay and heat sink.

 **Attention!**
Heat transfer compounds without silicon should not be used, since they may attack the plastic of the housing .

The solid-state relay is mounted to the heat sink using two M5x8 screws and matching washers. Both screws should be tightened in alternating fashion until a torque of 1 Nm is reached. After approx. one hour the screws need to be tightened further with a final torque of 2.5 Nm. This ensures that all excess heat transfer compound is squeezed out or that the graphite foil can well adapt to the contours of the surfaces.

Installation of the complete unit (Fig. 4)

The fins of the heat sink must be aligned in a manner allowing the unobstructed circulation of air. Without external fan, the fins must be aligned vertically to support natural convection.

Connection

	Control terminals	Load terminals
Screw:	M3 Pozidrive	M4 Pozidrive
Tightening torque:	0,5 Nm	1,2 Nm
Wire gauge:	1,5 mm ²	10 mm ²

 **Attention!** When using pneumatic or electric power screwdrivers, their torque limit must be set correctly.

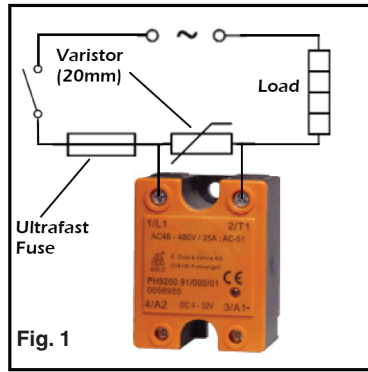

Fig. 1

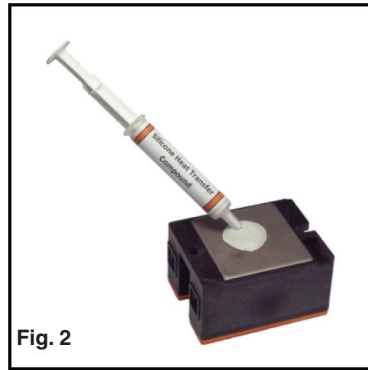

Fig. 2

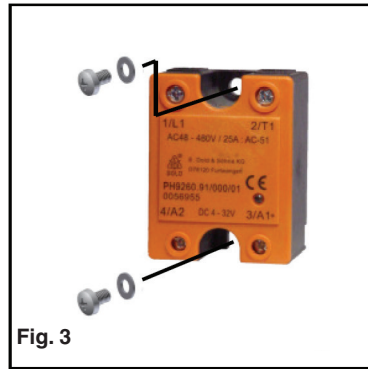

Fig. 3



Fig. 4

